

REVISIONS

ZONE	REV	DESCRIPTION	DATE	APPROVED

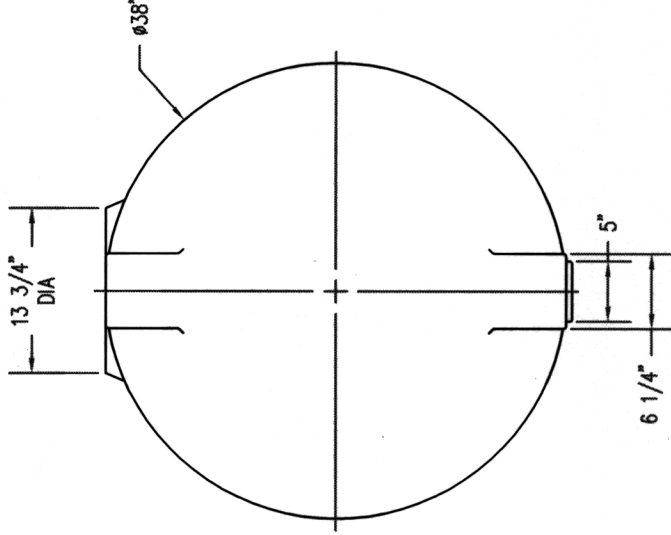
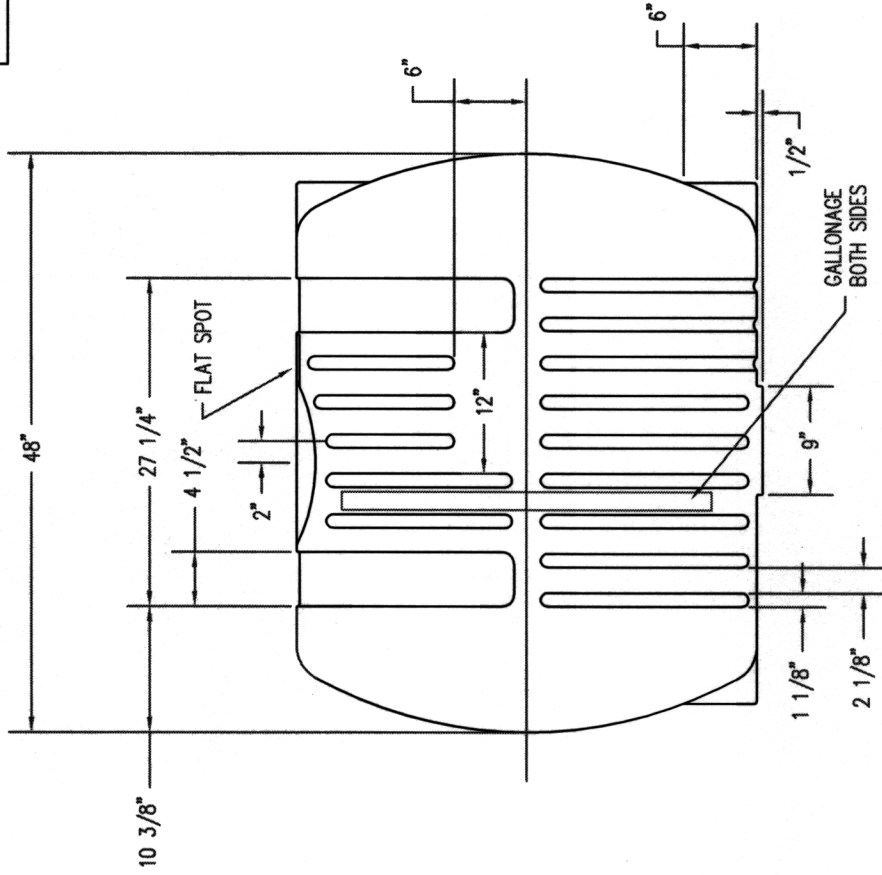

NORWESCO
ST. BONIFACIUS, MN

200 GALLON X 38 DIA
APPLICATOR TANK

JTP	26JUN03	SIZE	FSCM NO.	DWG NO.	REV
		A		47176/47325	
SCALE 1/16				SHEET	